



Washer

User manual

WF45T6000A*

SAMSUNG

Contents

Safety information	4
What you need to know about the safety instructions	4
Important safety symbols	4
Important safety precautions	5
CALIFORNIA PROPOSITION 65 WARNING	6
Critical installation warnings	6
Installation cautions	8
Critical usage warnings	8
Usage cautions	10
Critical cleaning warnings	13
Installation	14
Unpacking your washer	14
What's included	15
Installation requirements	17
Step-by-step installation	21
Before you start	26
Initial settings	26
Laundry guidelines	26
Detergent drawer guidelines	28
Operations	31
Control panel	31
Simple steps to start	34
Cycle overview	35
Cycle chart	36
Special features	38

Maintenance	40
Self Clean ⁺	40
Smart Care	41
Emergency drain	42
Cleaning	43
Recovery from freezing	46
Care for an extended period of non-use	47
Cleaning the exterior	47
Cleaning the interior	47
Troubleshooting	48
Checkpoints	48
Information codes	52
Specifications	54
Fabric care chart	54
Protecting the environment	55
Declaration of conformity	55
Specification sheet	56

Safety information

Congratulations on your new Samsung washer. This manual contains important information on the installation, use and care of your appliance. Please take some time to read this manual to take full advantage of your washer's many benefits and features.

What you need to know about the safety instructions

Please read this manual thoroughly to ensure that you know how to safely and efficiently operate the extensive features and functions of your new appliance. Please store the manual in a safe location close to the appliance for future reference. Use this appliance only for its intended purpose as described in this instruction manual.

Warnings and Important Safety Instructions in this manual do not cover all possible conditions and situations that may occur. It is your responsibility to use common sense, caution and care when installing, maintaining and operating your washer.

Because the following operating instructions cover various models, the characteristics of your washer may differ slightly from those described in this manual and not all warning signs may be applicable. If you have any questions or concerns, contact your nearest service center or find help and information online at www.samsung.com.

Important safety symbols

What the icons and signs in this user manual mean:

 **WARNING**

Hazards or unsafe practices that may result in **severe personal injury, death and/or property damage.**

 **CAUTION**

Hazards or unsafe practices that may result in **personal injury and/or property damage.**

 **NOTE**

Indicates that a risk of personal injury or material damage exists.

These warning signs are here to prevent injury to yourself and others.

Please follow them explicitly.

After reading this manual, store it in a safe place for future reference.

Read all instructions before using the appliance.

As with any equipment that uses electricity and moving parts, potential hazards exist.

To safely operate this appliance, familiarize yourself with its operation and exercise care when using it.

SAVE THESE INSTRUCTIONS

Important safety precautions

WARNING

To reduce the risk of fire, electric shock, or injury to persons when using your appliance, follow basic precautions, including the following:

1. Read all instructions before using the appliance.
2. Do not wash or dry articles that have been previously cleaned in, washed in, soaked in, or spotted with gasoline, dry-cleaning solvents, other flammable or explosive substances as they give off vapors that could ignite or explode.
3. Do not allow children to play on or in the appliance. Close supervision of children is necessary when the appliance is used near children.
4. Before the appliance is removed from service or discarded, remove the door to the washing or drying compartment.
5. Do not reach into the appliance if the drum is moving.
6. Do not install or store this appliance where it will be exposed to the weather.
7. Do not tamper with controls.
8. Do not repair or replace any part of the appliance or attempt any servicing unless specifically recommended in the user-maintenance instructions or in published user repair instructions that you understand and have the skills to carry out.
9. Do not add gasoline, dry-cleaning solvents, or other flammable or explosive substances to the wash water. These substances give off vapors that could ignite or explode.
10. Under certain conditions, hydrogen gas may be produced in a hot water system that has not been used for 2 weeks or more. **HYDROGEN GAS IS EXPLOSIVE.** If the hot water system has not been used for such a period, before using a washer or combination washer-dryer, turn on all hot water faucets and let the water flow from each for several minutes. This will release any accumulated hydrogen gas. As the gas is flammable, do not smoke or use an open flame during this time.

SAVE THESE INSTRUCTIONS

Safety information

CALIFORNIA PROPOSITION 65 WARNING

WARNING

Cancer and Reproductive Harm - www.P65Warnings.ca.gov.

Critical installation warnings

WARNING

The installation of this appliance must be performed by a qualified technician or service company.

- Failure to do so may result in electric shock, fire, an explosion, problems with the product, or injury.

The appliance is heavy, therefore take care when lifting it.

Plug the power cord into a wall socket that meets local electrical specifications. Use the socket for this appliance only, and do not use an extension cord.

- Sharing a wall socket with other appliances, using a power strip, or extending the power cord may result in electric shock or fire.
- Ensure that the voltage, frequency, and current supplied to the washer matches those listed in the product specifications. Failure to do so may result in electric shock or fire. Plug the power plug into the wall socket firmly.

Remove all foreign substances such as dust or water from the power plug terminals and contact points using a dry cloth on a regular basis.

- Unplug the power plug and clean it with a dry cloth.
- Failure to do so may result in electric shock or fire.

Plug the power plug into the wall socket so that the cord is running towards the floor.

- If you plug the power plug into the socket in the opposite direction, the electric wires within the cable may be damaged and this may result in electric shock or fire.

Keep all packaging materials out of the reach of children as these may be dangerous.

- If a child places a plastic bag over his or her head, he or she can suffocate.

If the appliance, power plug, or power cord is damaged, contact your nearest service center.

This appliance must be properly grounded.

SAVE THESE INSTRUCTIONS

Do not ground the appliance to a gas pipe, plastic water pipe, or telephone line.

- This may result in electric shock, fire, an explosion, or problems with the product.
- Never plug the power cord into a socket that is not grounded correctly. Make sure that the socket is in accord with local and national regulations.

Do not install this appliance near a heater or any flammable material.

Do not install this appliance in a humid, oily or dusty location, or in a location exposed to direct sunlight or water (rain drops).

Do not install this appliance in a location exposed to low temperatures:

- Frost may cause the tubes to burst.

Do not install this appliance in a location where gas may leak:

- This may result in electric shock or fire.

Do not use an electric transformer to power the washer.

- This may result in electric shock or fire.

Do not use a damaged power plug, damaged power cord, or loose wall socket.

- This may result in electric shock or fire.

Do not pull or bend the power cord excessively.

Do not twist or tie the power cord.

Do not hook the power cord over a metal object, place a heavy object on the power cord, insert the power cord between objects, or push the power cord into the space behind the appliance.

- This may result in electric shock or fire.

Do not pull the power cord when unplugging the power plug.

- Unplug the power plug by pulling the plug.
- Failure to do so may result in electric shock or fire.

This appliance should be positioned so that the power plug, the water supply taps, and the drain pipes are accessible.

SAVE THESE INSTRUCTIONS

Safety information

Installation cautions

CAUTION

This appliance should be positioned in such a way that the power plug is easily accessible.

- Failure to do so may result in electric shock or fire due to electric leakage.

Install your appliance on a solid, level floor that can support its weight.

- Failure to do so may result in abnormal vibrations, movement, noise, or problems with the product.

Critical usage warnings

WARNING

If the appliance is flooded, turn off the water & power supplies immediately and contact your nearest service center.

- Do not touch the power plug with wet hands.
- Failure to do so may result in electric shock.

If the appliance generates a strange noise, a burning smell, or smoke, unplug the power plug immediately and contact your nearest service center.

- Failure to do so may result in electric shock or fire.

In the event of a gas leak (such as propane gas, LP gas, etc.), ventilate immediately without touching the power plug. Do not touch the appliance or power cord.

- Do not use a ventilating fan.
- A spark may result in an explosion or fire.

Do not let children play in or on the washer. In addition, when disposing of the appliance, remove the washer door lever.

- Children can suffocate to death if trapped inside the product.

Make sure to remove the packaging (sponge, styrofoam) attached to the bottom of the washer before using it.

Do not wash items contaminated with gasoline, kerosene, benzene, paint thinner, alcohol, or other flammable or explosive substances in the washer.

- This may result in electric shock, fire, or an explosion.

Do not open the washer door by force while it is operating (high-temperature washing/drying/spinning).

SAVE THESE INSTRUCTIONS

- Water flowing out of the washer may result in burns or cause the floor to be slippery. This may result in injury.
- Opening the door by force may result in damage to the product or injury.

Do not insert your hand under the washer while an operation is in progress.

- This may result in injury.

Do not touch the power plug with wet hands.

- This may result in electric shock.

Do not turn the appliance off by unplugging the power plug while an operation is in progress.

- Plugging the power plug into the wall socket again may cause a spark and result in electric shock or fire.

Do not let children or the infirm use this washer without proper supervision. Do not let children climb in or onto the appliance.

- This may result in electric shock, burns, or injury.

Do not insert your hand or a metal object under the washer while it is operating.

- This may result in injury.

Do not unplug the appliance by pulling the power cord. Always grip the plug firmly and pull it straight out of the outlet.

- Damage to the power cord may cause a short-circuit, fire, and/or electric shock.

Do not attempt to repair, disassemble, or modify the appliance yourself.

- Do not use a fuse (such as copper, steel wire, etc.) other than a standard fuse.
- When the appliance needs to be repaired or reinstalled, contact your nearest service center.
- Failure to do so may result in electric shock, fire, problems with the product, or injury.

If the water supply hose comes loose from the faucet and floods the appliance, unplug the power plug.

- Failure to do so may result in electric shock or fire.

Unplug the power plug when the appliance is not being used for long periods of time or during a thunder or lightning storm.

- Failure to do so may result in electric shock or fire.

If any foreign substance enters the appliance, unplug the power plug and contact your nearest Samsung Customer Service.

SAVE THESE INSTRUCTIONS

Safety information

- This may result in electric shock or fire.

Do not let children (or pets) play in or on your washer. The washer door does not open easily from the inside and children may be seriously injured if trapped inside.

Usage cautions

CAUTION

If the washer is contaminated by a foreign substance such as detergent, dirt, food waste, etc., unplug the power plug and clean the washer using a damp, soft cloth.

- Failure to do so may result in discoloration, deformation, damage, or rust.

The front glass may be broken by a strong impact. Take care when using the washer.

- If the glass is broken, it may result in injury.

After a water supply failure or when reconnecting the water supply hose, open the faucet slowly.

Open the faucet slowly after a long period of non-use.

- The air pressure in the water supply hose or the water pipe may damage a product part or result in a water leak.

If a draining error occurs during an operation, check if there is a draining problem.

- If the washer is used when it is flooded because of a draining problem, it may result in electric shock or fire.

Insert the laundry into the washer completely so that the laundry does not get caught in the door.

- If laundry gets caught in the door, it may result in damage to the laundry or the washer, or result in a water leak.

Turn the water supply off when the washer is not being used.

- Ensure that the water supply hose connectors are properly tightened.

Ensure that the rubber seal and front door glass are not contaminated by a foreign substance (e.g. waste, thread, hair, etc.).

- If a foreign substance is caught in the door or the door is not completely closed, it may cause a water leak.

Open the faucet and check if the water supply hose connectors are firmly tightened and that there are no water leaks before using the product.

SAVE THESE INSTRUCTIONS

- If the connectors on the water supply hoses are loose, it may result in a water leak.

The product you have purchased is designed for domestic use only.

Using the product for business purposes qualifies as a product misuse. If the product is used for business purposes, it will not be covered by the standard warranty provided by Samsung and no responsibility can be attributed to Samsung for malfunctions or damages resulting from such misuse.

Do not stand on the appliance or place objects (such as laundry, lighted candles, lighted cigarettes, dishes, chemicals, metal objects, etc.) on the appliance.

- This may result in electric shock, fire, problems with the product, or injury.

Do not spray volatile material such as insecticide onto the surface of the appliance.

- As well as being harmful to humans, this may result in electric shock, fire, or problems with the product.

Do not place objects that generate electromagnetic fields near the washer.

- This may result in injury due to a malfunction.

Water drained during a high-temperature wash or drying cycle is hot. Do not touch the water.

- This may result in burns or injury.

Do not wash, spin, or dry water-proof seats, mats, or clothing (*) unless your appliance has a special cycle for washing these items.

(*): Woolen bedding, rain covers, fishing vests, ski pants, sleeping bags, diaper covers, sweat suits, and bicycle, motor cycle and car covers, etc.

- Do not wash thick or hard mats even if the washer mark is on the care label. This may result in injury or damage to the washer, walls, floor, or clothing due to abnormal vibrations.
- Do not wash throw rugs or doormats with rubber backing. The rubber backing may come off and stick to inside the drum, and this may result in malfunction such as a drainage error.

Do not operate the washer when the detergent drawer is removed.

- This may result in electric shock or injury due to a water leak.

Do not touch the insides of the drum during or just after drying as it is hot.

- This may result in burns.

SAVE THESE INSTRUCTIONS

Safety information

The door glass becomes hot during washing and drying. Therefore, do not touch the door glass.

Also, do not allow children to play around the washing machine or touch the door glass.

- This may result in burns.

Do not insert your hand into the detergent drawer.

- This may result in injury as your hand may be caught by the detergent input device.
- Do not use the liquid detergent container (on applicable models only) for powdered detergent. Remove the container and put powdered detergent directly into the Main wash compartment.

Do not place any objects (such as shoes, food waste, animals) other than laundry into the washer.

- This may result in damage to the washer, or injury and death in the case of pets, due to the abnormal vibrations.

Do not press the buttons using sharp objects such as pins, knives, fingernails, etc.

- This may result in electric shock or injury.

Do not wash laundry contaminated by oils, creams, or lotions usually found in skincare shops or massage clinics.

- This may cause the rubber seal to become deformed and result in a water leak.

Do not leave metal objects such as safety pins, hair pins or bleach in the drum for long periods of time.

- Doing either may cause the drum to rust.
- If rust starts appearing on the surface of the drum, apply a (neutral) cleansing agent to the surface and use a sponge to clean it. Never use a metal brush.

Do not use dry cleaning detergent directly and do not wash, rinse, or spin laundry contaminated by dry cleaning detergent.

- This may result in spontaneous combustion or ignition due to the heat from the oxidation of the oil.

Do not use water from water cooling/heating devices.

- This may result in problems with the washer.

Do not use natural hand-washing soap for the washer.

- If it hardens and accumulates inside the washer, it may result in problems with the product, discoloration, rust, or bad odors.

SAVE THESE INSTRUCTIONS

Place socks and brassieres in a washing net and wash them with the other laundry.

Do not wash large laundry items such as bedding in the washing net.

- Failure to do so may result in injury due to abnormal vibrations.

Do not use hardened detergent.

- If it accumulates inside the washer, it may result in a water leak.

Make sure that the pockets of all the clothing items to be washed are empty.

- Hard, sharp objects such as coins, safety pins, nails, screws, or stones can cause extensive damage to the appliance.

Do not wash clothing with large buckles, buttons, or other heavy metal objects in the washer.

Sort the laundry by color on the basis of its colorfastness and select the recommended cycle, water temperature, and additional functions.

- Failure to do this may result in discoloration or fabric damage.

Take care that children's fingers are not caught in the door when you close it.

- Failure to do so may result in injury.

Critical cleaning warnings

WARNING

Do not clean the appliance by spraying water directly onto it.

Do not use a strong acidic cleaning agent.

Do not use benzene, thinner, or alcohol to clean the appliance.

- This may result in discoloration, deformation, damage, electric shock, or fire.

Before cleaning or performing maintenance, unplug the appliance from the wall socket.

- Failure to do so may result in electric shock or fire.

SAVE THESE INSTRUCTIONS

Installation

Follow these instructions carefully to ensure proper installation of your washer and to prevent accidents when doing laundry.

⚠ WARNING

Certain internal parts are intentionally not grounded and may present a risk of electric shock only during servicing. Service personnel - Do not contact the following parts while the appliance is energized: Control board, heat sink, motor, inlet valve and pump.

Unpacking your washer

Unpack your washer and inspect it for shipping damage. Make sure you have received all the items shown on the next page. If your washer was damaged during shipping, or you do not have all of the items, call 1-800-SAMSUNG (1-800-726-7864). To prevent personal injury or strain, wear protective gloves whenever lifting or carrying the unit.

⚠ WARNING

Packing materials can be dangerous to children; Keep all packing material (plastic bags, polystyrene, etc.) well out of children's reach.

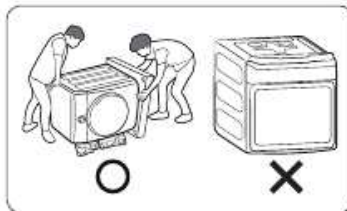

⚠ CAUTION

You must have at least 2 people unpack the washer. To remove the cushion bottom of the packing materials, do not tip the washer over on its front side.

When you lay the washer down to remove the carton base, protect the side of the washer and lay it down carefully. Never lay your washer on its back or front.

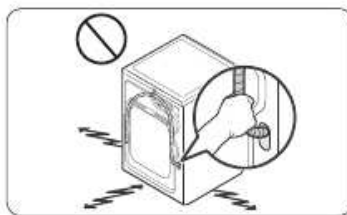

⚠ CAUTION

Do not grab or pull the drain hose to drag and move the product.

What's included

Make sure all the parts are included in the product package. If you have a problem with the washer or the parts, contact the Samsung customer care center at 1-800-SAMSUNG (1-800-726-7864) or your retailer.

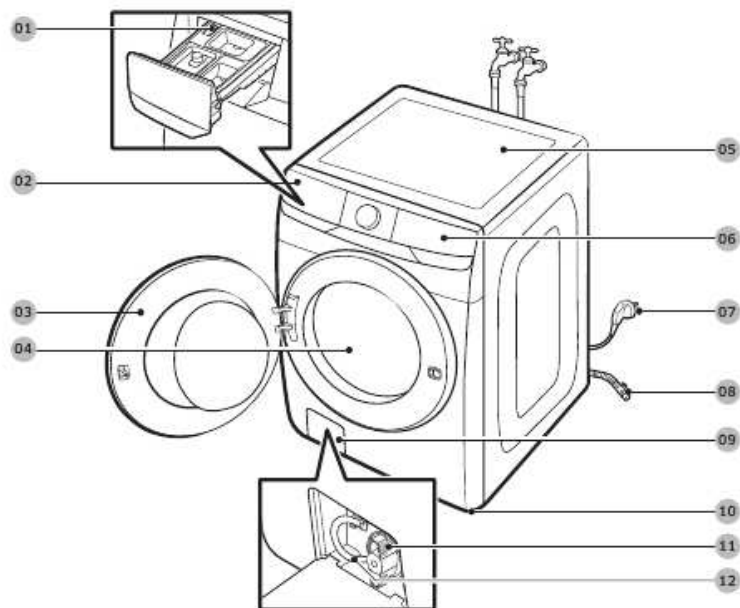

Installation

-
- | | | |
|------------------|---------------------|-------------------------|
| 01 Release lever | 02 Detergent drawer | 03 Door |
| 04 Drum | 05 Worktop | 06 Control panel |
| 07 Power plug | 08 Drain hose | 09 Filter cover |
| 10 Leveling feet | 11 Pump filter | 12 Emergency drain tube |

Installation

Parts supplied



Wrench



Bolt caps



Hose guide



Cable tie



Anti-slip pads

Parts not supplied



Water hoses (sold separately)

Tools needed for installation



Phillips screwdriver



Level



Adjustable pliers

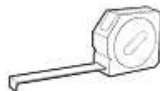

Measuring tape

NOTE

- Bolt caps: The number (3 to 6) of bolt caps provided depends on the model.
- The appearance of the washer and provided accessories may differ with the model.
- To purchase an accessory or lost part, contact a local Samsung service center or the retailer.

CAUTION

- Do not reuse old water hoses, which may leak or burst, causing flooding and/or property damage.
- Make sure rubber washers are inserted in each coupling of both water hoses.

Installation requirements

Electrical supply and grounding

- AC 120 V / 60 Hz / 15 AMP fuse or circuit breaker is required.
- Use an individual branch circuit. Connect only the washer to the circuit.

To ensure proper grounding, the washer comes with a power cord featuring a three-prong grounding plug for use in a properly installed and grounded outlet.

Check with a qualified electrician or service person if you are not sure about the grounding.

Do not modify the provided plug. If it does not fit the outlet, call a qualified electrician to install a proper outlet.

⚠ WARNING

- Do NOT use an extension cord.
- Use only the power cord that comes with the washer.
- Do NOT connect the ground wire to plastic plumbing, gas lines, or hot water pipes.
- Improperly connected grounding conductors may cause electric shock.
- To prevent unnecessary risk of fire, electrical shock, or personal injury, all wiring and grounding must be done in accordance with local codes, or in the absence of local codes, in accordance with the National Electrical Code, ANSI/NFPA No. 70-Latest Revision (for the U.S.) or the Canadian Electrical Code CSA C22.1 - Latest Revisions and local codes and ordinances. It is your responsibility to provide adequate electrical service for your washer.

Water supply

Proper water pressure for this washer is between 20-116 psi (137-800 kPa). Water pressure less than 20 psi (137 kPa) may cause the water valve not to close completely. Or, it may take longer to fill the drum, causing the washer to turn off. Water taps must be within 4 ft. (122 cm) from the rear of the washer so that the provided inlet hoses reach the washer.

To reduce the risk of leaks:

- Make sure water taps are easily accessible.
- Turn off the taps when the washer is not in use.
- Check for any leaks at the water inlet hose fittings on a regular basis.

⚠ CAUTION

Before using the washer for the first time, check all connections at the water valve and taps for any leaks.

Installation

Drain

Samsung recommends a standpipe 18 in. (460 mm) high. The drain hose must be connected through the hose clip to the standpipe, and the standpipe must fully cover the drain hose.

Flooring

For best performance, the washer must be installed on a solid floor. Wood floors may need to be reinforced to minimize vibration and/or unbalanced loads. Carpeting and soft tile surfaces do not provide good resistance to vibrations and may cause the washer to move slightly during the spin cycle.

⚠ CAUTION

Do NOT install the washer on a platform or a poorly supported structure.

Water temperature

Do not install the washer in areas where water may freeze as the washer always retains some water in its water valves, pumps, and/or hoses. Frozen water can cause damage to belts, the pump, and other components of the washer.

Dimensions

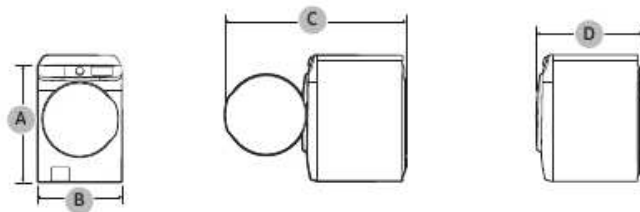

A. Overall height	38.7 in. (984 mm)
B. Width	27 in. (686 mm)
C. Depth with door open	52.6 in. (1337 mm)
D. Depth	31.3 in (796 mm)

Clearance requirement

This clearance requirement is applicable for washers only.

NOTE

- For dryer's clearance requirement, see the dryer's user manual.
- If the washer and dryer have different clearance requirements, use the one with the larger value.

Alcove or closet installations

Minimum clearance for stable operation:

Sides	Top	Rear	Front
1 in. (25 mm)	1 in. (25 mm)	5 in. (127 mm)	1 in. (25 mm)

If both the washer and a dryer are installed in the same location, the front of the alcove or closet must have two unobstructed air openings for a combined minimum total area of 72 in.² (465 cm²).

Undercounter installation

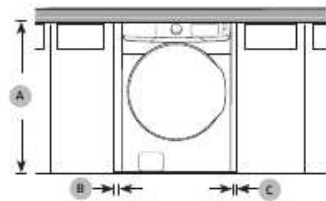

A	39.6 in. (1006 mm)
B	1 in. (25 mm)
C	1 in. (25 mm)

Pedestal installation

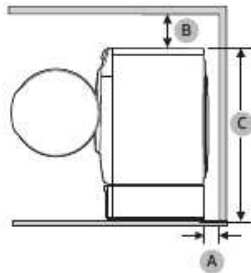

A	5 in. (127 mm)
B	6 in. (152 mm)
C	52.0 in. (1320 mm)

Installation

This clearance requirement is applicable for washer and dryer pair installation:

Side by side installation

Stacked installation (Model: SKK-8K)

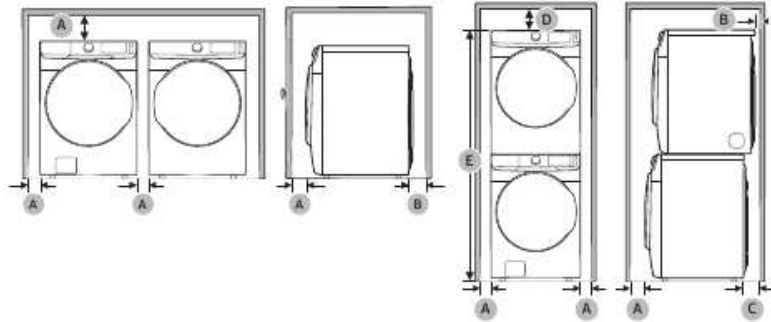

A	1 in. (25 mm)
B	5.9 in. (150 mm)
C	7.1 in. (180 mm)
D	6 in. (152 mm)
E	78.5 in. (1994 mm)

⚠ WARNING

- Samsung's washers and dryers can be stacked to maximize usable space.
- The dryer feet need to be removed to stack the washer and dryer. You can purchase an optional stacking kit from your Samsung retailer.

Installation

Step-by-step installation

STEP 1 Select a location

Location requirements:

- A solid, level surface without carpeting or flooring that may obstruct ventilation
- No direct sunlight
- Adequate room for ventilation and wiring
- Ambient temperature always higher than the freezing point (32 °F / 0 °C)
- Away from heat sources

STEP 2 Remove the shipping bolts



Unpack the product package and remove all shipping bolts.

1. Loosen all shipping bolts on the rear of the machine using the spanner.

NOTE

Use the enclosed end of the supplied wrench to remove the shipping bolts.



2. Fill the holes with the supplied plastic bolt caps.
Keep the shipping bolts for future use.

WARNING

- The shipping bolts secure the tub during product transportation and reduce the chance of suspension damage. Remove the shipping bolts before using the product and only reassemble them back in case you need to move the product.
- Packaging materials can be dangerous to children. Dispose all packaging material (plastic bags, polystyrene, etc.) out of children's reach.

Installation

STEP 3 Adjust the leveling feet

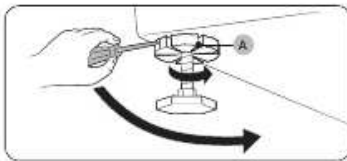
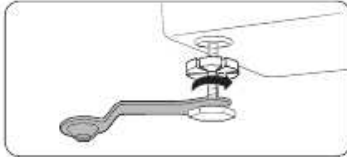

1. Gently slide the washer into position. Excessive force may damage the leveling feet.
2. Using a wrench, turn the leveling feet clockwise or counterclockwise to adjust the height until the washer is level.
3. Using a flathead screwdriver, tighten the locking nuts (A).

NOTE

Use the open-end of the supplied wrench to adjust the leveling feet.

STEP 4 Connect the water hose

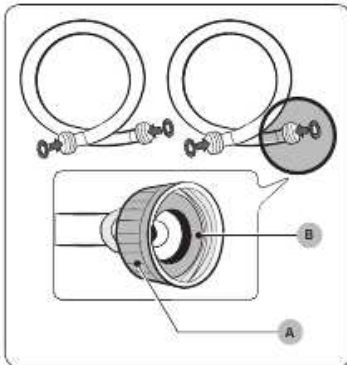

CAUTION

- Make sure to use new water hoses and that **rubber gaskets (B)** are inside the **couplings (A)** at both ends of the hoses. Water hoses without the gaskets may leak.
- Allow 5 in. (127 mm) of space between the back of the washer and the wall to prevent water hoses from being kinked. Kinked hoses may cause water leaks.
- If there is a water leak, stop using the washer and contact a local Samsung service center. A water leak may cause electric shock.
- Do not stretch the water hoses by force. If a hose is too short, replace the hose with a longer hose.

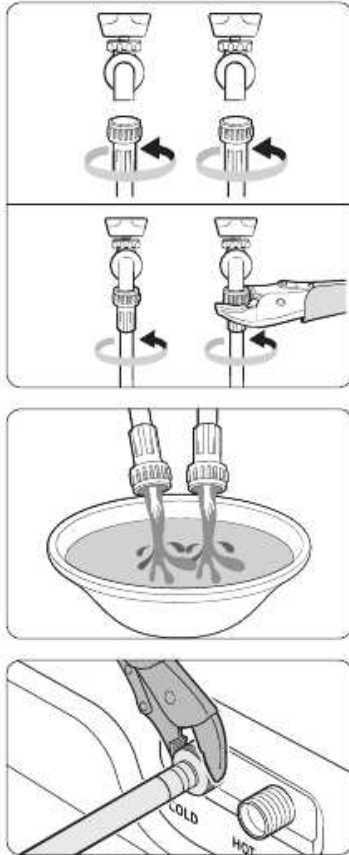

1. Attach the water hoses to the hot and cold water taps, and then hand tighten the water hose fittings until they are tight. Then, use pliers to tighten the fittings by an additional two-thirds of a turn. To avoid damaging the fittings, do not overtighten them.
2. Pull the water hoses to check if they are firmly connected.
3. Put the other ends of the hoses into a bucket, and then open the water taps for 10 - 15 seconds to remove impurities. When done, close the taps.
4. Attach the water hoses to the hot and cold water inlets on the back of the washer, and then hand tighten the water hose fittings until they are tight. Then, use pliers to tighten the fittings by an additional two-thirds of a turn.

NOTE

If you do not want to use the hot water supply hose, attach the water intake cap to the hot water supply intake. When you do a wash, press **Temp.** to select Cold.

Installation

Installation

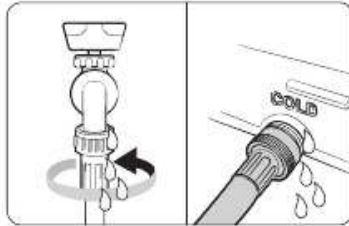

5. Open the water taps, and check for leaks.

STEP 5 Connect the drain hose

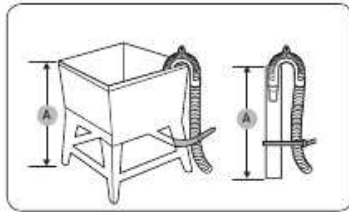

To a Laundry Tub or Drain Pipe

1. Check the **height (A)** of your drain system and make sure the minimum and maximum heights shown below are met.

Minimum	18 in. (46 cm)
Maximum	96 in. (245 cm)

NOTE

- Make sure to measure the height from the floor where the washer is placed.
 - Draining efficiency may be reduced if the drain system is at the maximum height.
 - To prevent the washer from siphoning water, do not use a drain system below the minimum height.
2. Attach the drain hose to the **plastic** hose guide (B).

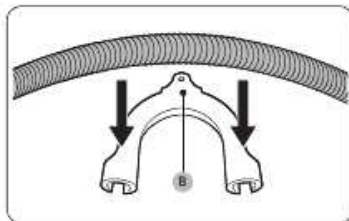

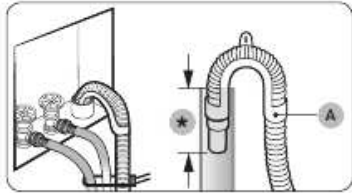

(*): Min. 6 in. (152 mm), Max. 8 in. (203 mm)

3. Route the drain hose to the drain system.

CAUTION

- If using a standpipe, make sure the standpipe and drain hose connection is not airtight.
- If using a standpipe, make sure the drain hose is inserted at least 6 in. (152 mm) but no more than 8 in. (203 mm) into the standpipe.

4. Secure the drain hose with cable ties.

Over the edge of a wash basin

The drain hose must be placed no lower than 24 in. (60 cm) and no higher than 35 in. (90 cm) from the floor. To keep the spout of the drain hose bent, use the supplied plastic **hose guide (A)**. Secure the guide to the wall using a hook to ensure stable drainage.

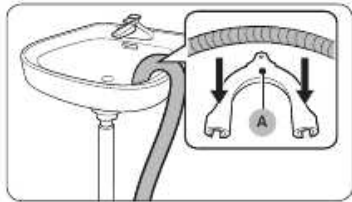

STEP 6 Remove the film inside the door

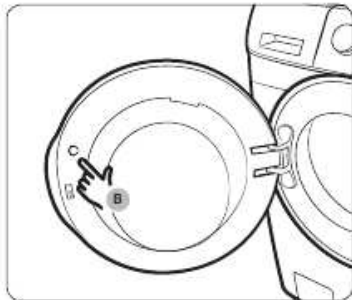

Remove the **small circle of film (B)** above the door latch before use.

STEP 7 Power on

Plug the power cord into an AC 120 V / 60 Hz / 15 AMP approved electrical outlet protected by a fuse or circuit breaker. Then, press **Power** to turn on the washer.

Before you start

Initial settings

Run Calibration (recommended)

Calibration ensures accurate weight detection by the washer. Make sure the drum is empty before running Calibration:

1. Press **Power** to turn on the washer.
2. Press and hold **Temp.** and **Delay End** simultaneously for 3 seconds.
3. Press and hold **Start/Pause (Hold to Start)** to start Calibration.
 - The door is locked during the operation.
 - The drum keeps rotating clockwise and counterclockwise for several minutes.
4. When complete, the washer turns off automatically.

Laundry guidelines

STEP 1 Sort

Sort the laundry according to these criteria:

- Care Label: Sort the laundry into cottons, mixed fibers, synthetics, silks, wools, and rayon.
- Color: Separate whites from colors.
- Size: Mixing different sized items together in the drum improves the washing performance.
- Sensitivity: Wash delicate items separately. For pure, new woolen items, curtains, and silk items, check the labels on the items.

NOTE

Make sure to check the care label on all clothing, and sort clothing accordingly before starting the wash.

STEP 2 Empty pockets

Empty all the pockets of your laundry items

- Metal objects such as coins, pins, and buckles on clothing may damage other laundry items as well as the drum.

Turn clothing with buttons and embroideries inside out

- If pants or jacket zippers are open while washing, the drum may be damaged. Zippers should be closed and fixed with a string.
- Clothing with long strings may become entangled with other clothes. Make sure to tie the strings before starting the wash.

STEP 3 Use a laundry net

- Brassieres (water washable) must be placed in a laundry net. Metal parts of the brassieres may break through and tear other laundry items.
- Small, light clothing such as socks, gloves, stockings, and handkerchiefs may become caught around the door. Place them inside a fine laundry net.
- Do not wash the laundry net by itself without other laundry. This may cause abnormal vibrations that could move the washer and result in injury.

STEP 4 Determine the load capacity

Do not overload the washer. Overloading may cause the washer to wash improperly.

 **NOTE**

When washing bedding or bedding covers, the wash time may be lengthened or the spin efficiency may be reduced.

For bedding or bedding covers, the recommended maximum spin level is Level 2 or Level 3, and the load capacity is 3.0 kg or less.

 **CAUTION**

If the laundry is unbalanced and the "UB" information code is displayed, redistribute the load. Unbalanced laundry may reduce spinning performance.

STEP 5 Add the correct detergent type

The type of detergent you use - general purpose, specifically for woolens, etc. - depends on the type of fabric (cotton, synthetic, delicate items, wool), color, wash temperature, and degree of soiling. Regardless of the specific type of detergent you use, always use "low suds" HE laundry detergent which is designed for automatic washers.

 **NOTE**

- Follow the detergent manufacturer's recommendations based on the weight of the laundry, the degree of soiling, and the hardness of the water in your local area. If you are not sure about the water hardness, contact your local water authority.
- Do not use detergent that tends to harden or solidify. This detergent may remain after the rinse cycle, blocking the drain outlet.

 **CAUTION**

When washing wool using the WOOL cycle, use only a neutral liquid detergent. Powdered detergent used with the WOOL cycle can remain on the laundry and discolor it.

Before you start

Use HE detergent only



Your washer is designed to use high efficiency (HE) detergents.

- For the best cleaning results, use a high efficiency detergent such as Tide HE, Wisk HE, Cheer HE or Gain HE*. High efficiency detergents contain suds suppressors that reduce or eliminate suds. When fewer suds are produced, the load tumbles more efficiently and cleaning is maximized. (* Brand names are trademarks of their respective manufacturers.)

WARNING

For best results, use HE detergents only. Do not use non-HE detergent, organic detergent, natural detergent or HE detergents with natural ingredients (such as vinegar, baking soda).

Detergent drawer guidelines

The washer provides a three-compartment dispenser: the front-left compartment for the main wash, the front-right for fabric softeners, and the rear-right for the liquid chlorine bleach.

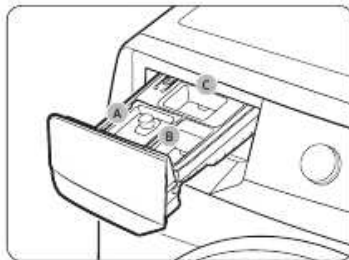

- A. Main-wash compartment:** Add main-wash detergent, water softener, soaking detergent, color-safe, and/or stain removers.
- B. Softener compartment:** Add fabric softener. Do not exceed the **max line**.
- C. Bleach compartment:** Add liquid chlorine bleach. Do not exceed the **max line**.

⚠ CAUTION

- Do not open the detergent drawer while the washer is operating.
- Do not put a tablet or capsule type detergents into the detergent drawer. Put them directly into the drum.
- Do not use a ball type detergent.
- To prevent the compartment from clogging, concentrated or highly-enriched agents (fabric softener or detergent) must be diluted with water before being added.

To add washing agents to the detergent drawer

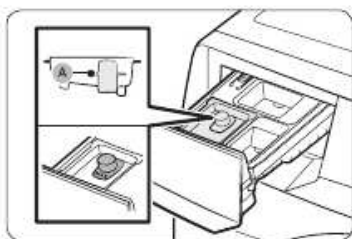

1. Slide open the detergent drawer.
2. Add liquid laundry detergent to the liquid detergent container in the main wash compartment.

⚠ CAUTION

- Make sure the liquid detergent container is inserted in the main wash compartment.
- Do not exceed the marked **max line (A)**.

📖 NOTE

- Do not add powdered laundry detergent or other powdered laundry agents to the liquid laundry container.
- To use powdered detergent, see page 30.

3. Add fabric softener to the **softener compartment**. Do not exceed the **max line (B)**.

⚠ CAUTION

- Powdered fabric softener is not recommended. Use liquid fabric softener only.
- Concentrated fabric softener must be diluted with water before being added.
- Do not add main-wash detergent to the **softener compartment**.

4. Close the detergent drawer.

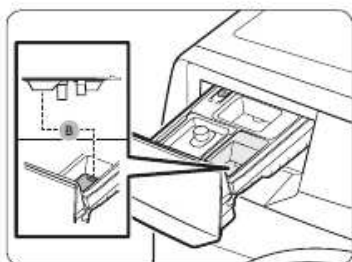

Before you start

Before you start

To use powdered detergent

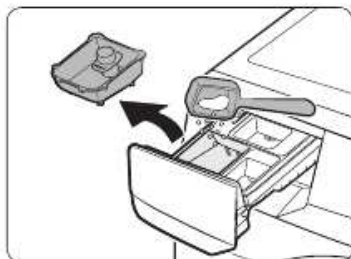

First, remove the provided liquid detergent container from the **main-wash compartment**. Then, add powdered detergent to the **main-wash compartment** according to the detergent manufacturer's instructions.

⚠ CAUTION

Do not add powdered detergent to the liquid detergent container.

To use the bleach compartment

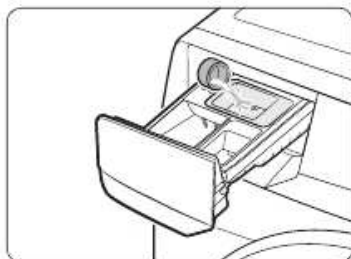

Add only liquid chlorine bleach to the **bleach compartment**. Do not exceed the **max line**.

⚠ CAUTION

Do not add undiluted liquid chlorine bleach directly to the load or to the drum. It is a powerful chemical and can cause fabric damage, such as weakening of the fibers or color loss if not used properly.

To use oxygen boosters or color-safe bleach

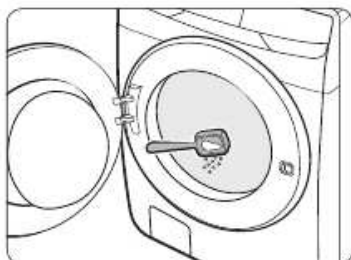

Oxygen boosters or color-safe bleach can increase washing performance. Make sure to add the oxygen booster or color-safe bleach after putting the laundry into the drum.

📌 NOTE

To use both powdered detergent and powdered oxygen booster or powdered color-safe bleach, it is more effective to put them together into the drum before loading the laundry.

Operations

⚠ WARNING

To reduce the risk of fire, electric shock, or injury to persons, read the Safety information before operating this appliance.

Control panel

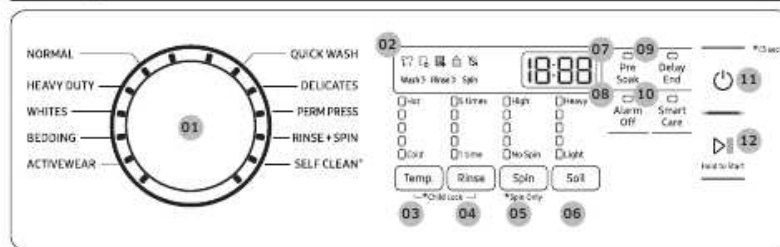

01 Cycle Selector	Turn the dial to select a cycle. (For more information about wash cycles, see page 35.)
02 Display	The display shows current cycle information and estimated time remaining, or an information code if the washer needs to be checked.
03 Temp.	Press to change the water temperature for the current cycle. <ul style="list-style-type: none"> • Hot (Level 5): Heavily soiled, colorfast items. Only available with NORMAL, HEAVY DUTY and SELF CLEAN*. • (Level 4): Whites and heavily soiled, colorfast items. • (Level 3): Colorfast items. • (Level 2): Brightly colored, very lightly soiled items. • Cold (Level 1): Uses only cold water without utilizing the washer's heater. No warm water is supplied.
04 Rinse	Press to change the rinse count for the current cycle. <ul style="list-style-type: none"> • You can select 1 to 5 rinses.





Operations

Operations

05 Spin	<p>Press to change the spinning speed for the current cycle.</p> <ul style="list-style-type: none"> • High (Level 5): Extends the spinning process to effectively remove moisture from the load. This level uses a stronger spinning process to remove moisture, so it is not suitable for wrinkle-free or non-iron fabrics, or overloads. • (Level 4): Underwear, t-shirts, jeans, and sturdy cottons. • (Level 3): Jeans, wrinkle-free or wash-and-wear items, and synthetics. • (Level 2): Delicate items that require a lower spinning speed. • No Spin (Level 1): The drum does not spin after the final drain process. <p>Rinse hold (All indicators are off): The final rinse process is suspended so that the laundry remains in the water. To unload the laundry, run a drain or spin process.</p> <p> NOTE</p> <p>Spin Only: To perform the spin process only, press and hold Spin for 3 seconds. With the cycle time on the display, press Spin repeatedly until a desired spinning speed is selected. Then, press and hold Start/Pause (Hold to Start) to start.</p>
06 Soil	<p>Press to change the soil level for the current cycle.</p> <ul style="list-style-type: none"> • Heavy (Level 5): For extremely soiled loads. • (Level 4): For heavily soiled loads. • (Level 3): For moderately soiled loads. This setting is best for most loads. • (Level 2): For lightly soiled loads. • Light (Level 1): For barely soiled loads.
07 Pre Soak	<p>Press to add 30 minutes of soaking time at the start of the wash cycle for better stain removal.</p>
08 Alarm Off	<p>Press to turn the alarm sound on or off. When the alarm is off, the cycle completion melody and the power-off beep will not sound. However, button and alert sounds will remain on.</p>
09 Delay End	<p>Set the washer to finish your wash automatically at later time. Choose a delay of between 1 to 24 hours (in 1 hour increments). (For more information about Delay End, see page 38.)</p>
10 Smart Care	<p>This function enables you to check the status of the washer using a smartphone.</p>
11 Power	<p>Press to turn the washer on or off.</p>

12 Start/Pause (Hold to Start)	Press and hold to start operation or press to stop operation temporarily.
--	---

Icon description

	Garment+	<ul style="list-style-type: none"> This icon indicates you can add or take out items after a cycle has started. To add or take out items, press Start/Pause (Hold to Start) to pause the cycle, and then open the door. To resume the cycle, close the door, and then press and hold Start/Pause (Hold to Start).
	Door Lock	<ul style="list-style-type: none"> This icon indicates the door is locked and cannot be opened. The door locks automatically during a cycle and this indicator turns on. You can open the door when this icon disappears.
	SELF CLEAN+ reminder	<ul style="list-style-type: none"> This icon indicates that you should clean the drum using the SELF CLEAN+ cycle. After every 40 cycles, this icon appears for an hour and then turns off automatically. The icon will appear for 5 more cycles, turn off, and then will not appear for another 40 cycles.
	Child Lock	<ul style="list-style-type: none"> This icon indicates that Child Lock is on. For more information on Child Lock, see page 39.
	Alarm Off	<ul style="list-style-type: none"> This icon indicates that the alarm is off. For more information on Alarm Off, see page 39.

Operations

Simple steps to start

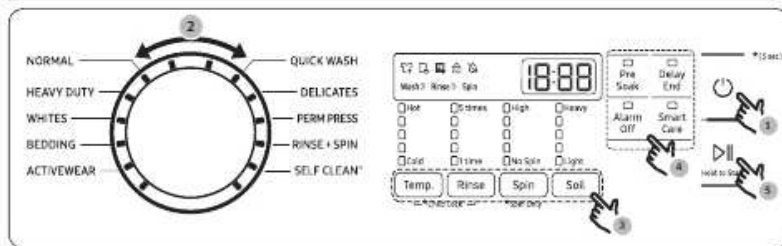

1. Press Power to turn on the washer.
2. Turn the Cycle Selector to select a cycle.
3. Change the cycle settings (Temp., Rinse, Spin, and Soil) as necessary.
4. Select desired options as necessary.
5. Press and hold Start/Pause (Hold to Start).

To change the cycle during operation

1. Press Start/Pause (Hold to Start) to stop operation.
2. Select a different cycle.
3. Press and hold Start/Pause (Hold to Start) again to start the new cycle.

⚠ WARNING

Do not place anything on top of your washer while it is running.

Cycle overview

NOTE

The washer detects the weight of the items and automatically adjusts the optimal water level, washing time, rinse counts, and spin counts. (This may not be applicable on some cycles.)

Cycle	Description
NORMAL	<ul style="list-style-type: none"> For cottons, bed linens, table linens, underwear, towels, or shirts. The washing time and the number of rinses are automatically adjusted according to the load.
HEAVY DUTY	<ul style="list-style-type: none"> For sturdy, colorfast fabrics and heavily soiled items.
WHITES	<ul style="list-style-type: none"> For white items. You can wash with or without bleach.
BEDDING	<ul style="list-style-type: none"> For bulky items such as comforters, blankets, and sheets. For best results, wash only 1 type of bedding. For bulky items, use liquid detergent and do not roll the items in the drum because they might get stuck in the drum.
ACTIVEWEAR	<ul style="list-style-type: none"> For exercise wear such as sports jerseys, training pants, shirts/tops and other performance clothing. This cycle provides effective soil removal with controlled drum rotation for special fabric care.
QUICK WASH	<ul style="list-style-type: none"> For lightly soiled items that you want to finish washing quickly. For best performance, recommended load is 4 lb or lower.
DELICATES	<ul style="list-style-type: none"> For sheer fabrics, bras, lingerie (silk), and other handwash-only fabrics. For best performance, use liquid detergent.
PERM PRESS	<ul style="list-style-type: none"> For wash-and-wear, synthetic fabrics, and lightly to normally soiled items.
RINSE+SPIN	<ul style="list-style-type: none"> Features an additional rinse process after fabric softener is applied to the laundry.
SELF CLEAN*	<ul style="list-style-type: none"> Cleans the drum by removing dirt and bacteria from the drum. Perform once every 40 washes. Make sure the drum is empty.

Operations

Cycle chart

Use this chart to set the best cycle and options for your laundry.

NOTE

Setting	Temp.	Rinse	Spin	Soil
● : factory setting	5 : Hot (Level 5)	5 : 5 times (Level 5)	5 : High (Level 5)	5 : Heavy (Level 5)
○ : can be selected	4 : (Level 4)	4 : (Level 4)	4 : (Level 4)	4 : (Level 4)
	3 : (Level 3)	3 : (Level 3)	3 : (Level 3)	3 : (Level 3)
	2 : (Level 2)	2 : (Level 2)	2 : (Level 2)	2 : (Level 2)
	1 : Cold (Level 1)	1 : 1 time (Level 1)	1 : No spin (Level 1)	1 : Light (Level 1)

Cycle	Functions									
	Temp.					Rinse				
	5	4	3	2	1	5	4	3	2	1
NORMAL	<input type="checkbox"/>	<input type="checkbox"/>	<input checked="" type="checkbox"/>	<input type="checkbox"/>	<input type="checkbox"/>	<input type="checkbox"/>	<input type="checkbox"/>	<input type="checkbox"/>	<input checked="" type="checkbox"/>	<input type="checkbox"/>
HEAVY DUTY	<input type="checkbox"/>	<input checked="" type="checkbox"/>	<input type="checkbox"/>	<input type="checkbox"/>	<input type="checkbox"/>	<input type="checkbox"/>	<input type="checkbox"/>	<input type="checkbox"/>	<input checked="" type="checkbox"/>	<input type="checkbox"/>
WHITES	<input type="checkbox"/>	<input type="checkbox"/>	<input checked="" type="checkbox"/>	<input type="checkbox"/>	<input type="checkbox"/>	<input type="checkbox"/>	<input type="checkbox"/>	<input type="checkbox"/>	<input checked="" type="checkbox"/>	<input type="checkbox"/>
BEDDING			<input checked="" type="checkbox"/>	<input type="checkbox"/>	<input type="checkbox"/>	<input type="checkbox"/>	<input type="checkbox"/>	<input type="checkbox"/>	<input checked="" type="checkbox"/>	<input type="checkbox"/>
ACTIVEWEAR			<input checked="" type="checkbox"/>	<input type="checkbox"/>	<input type="checkbox"/>	<input type="checkbox"/>	<input type="checkbox"/>	<input type="checkbox"/>	<input checked="" type="checkbox"/>	<input type="checkbox"/>
QUICK WASH		<input type="checkbox"/>	<input checked="" type="checkbox"/>	<input type="checkbox"/>	<input type="checkbox"/>	<input type="checkbox"/>	<input type="checkbox"/>	<input type="checkbox"/>	<input type="checkbox"/>	<input checked="" type="checkbox"/>
DELICATES			<input type="checkbox"/>	<input type="checkbox"/>	<input checked="" type="checkbox"/>			<input type="checkbox"/>	<input checked="" type="checkbox"/>	<input type="checkbox"/>
PERM PRESS			<input checked="" type="checkbox"/>	<input type="checkbox"/>	<input type="checkbox"/>	<input type="checkbox"/>	<input type="checkbox"/>	<input type="checkbox"/>	<input checked="" type="checkbox"/>	<input type="checkbox"/>
RINSE+SPIN						<input type="checkbox"/>	<input type="checkbox"/>	<input type="checkbox"/>	<input type="checkbox"/>	<input checked="" type="checkbox"/>
SELF CLEAN [†]	<input checked="" type="checkbox"/>								<input checked="" type="checkbox"/>	

Operations

Cycle	Functions									
	Spin					Soil				
	5	4	3	2	1	5	4	3	2	1
NORMAL	<input type="checkbox"/>	<input checked="" type="checkbox"/>	<input type="checkbox"/>	<input type="checkbox"/>	<input type="checkbox"/>	<input type="checkbox"/>	<input type="checkbox"/>	<input checked="" type="checkbox"/>	<input type="checkbox"/>	<input type="checkbox"/>
HEAVY DUTY	<input checked="" type="checkbox"/>	<input type="checkbox"/>	<input type="checkbox"/>	<input type="checkbox"/>	<input type="checkbox"/>	<input checked="" type="checkbox"/>	<input type="checkbox"/>	<input type="checkbox"/>	<input type="checkbox"/>	<input type="checkbox"/>
WHITES	<input type="checkbox"/>	<input checked="" type="checkbox"/>	<input type="checkbox"/>	<input type="checkbox"/>	<input type="checkbox"/>	<input type="checkbox"/>	<input type="checkbox"/>	<input checked="" type="checkbox"/>	<input type="checkbox"/>	<input type="checkbox"/>
BEDDING	<input type="checkbox"/>	<input type="checkbox"/>	<input type="checkbox"/>	<input checked="" type="checkbox"/>	<input type="checkbox"/>	<input type="checkbox"/>	<input type="checkbox"/>	<input checked="" type="checkbox"/>	<input type="checkbox"/>	<input type="checkbox"/>
ACTIVEWEAR	<input type="checkbox"/>	<input type="checkbox"/>	<input type="checkbox"/>	<input checked="" type="checkbox"/>	<input type="checkbox"/>	<input type="checkbox"/>	<input type="checkbox"/>	<input checked="" type="checkbox"/>	<input type="checkbox"/>	<input type="checkbox"/>
QUICK WASH	<input checked="" type="checkbox"/>	<input type="checkbox"/>	<input type="checkbox"/>	<input type="checkbox"/>	<input type="checkbox"/>	<input type="checkbox"/>	<input type="checkbox"/>	<input type="checkbox"/>	<input type="checkbox"/>	<input checked="" type="checkbox"/>
DELICATES	<input type="checkbox"/>	<input type="checkbox"/>	<input checked="" type="checkbox"/>	<input type="checkbox"/>	<input type="checkbox"/>	<input type="checkbox"/>	<input type="checkbox"/>	<input checked="" type="checkbox"/>	<input type="checkbox"/>	<input type="checkbox"/>
PERM PRESS	<input type="checkbox"/>	<input type="checkbox"/>	<input type="checkbox"/>	<input checked="" type="checkbox"/>	<input type="checkbox"/>	<input type="checkbox"/>	<input type="checkbox"/>	<input checked="" type="checkbox"/>	<input type="checkbox"/>	<input type="checkbox"/>
RINSE+SPIN	<input type="checkbox"/>	<input checked="" type="checkbox"/>	<input type="checkbox"/>	<input type="checkbox"/>	<input type="checkbox"/>	<input type="checkbox"/>	<input type="checkbox"/>	<input type="checkbox"/>	<input type="checkbox"/>	<input type="checkbox"/>
SELF CLEAN ⁺	<input checked="" type="checkbox"/>	<input type="checkbox"/>	<input type="checkbox"/>	<input type="checkbox"/>	<input type="checkbox"/>	<input type="checkbox"/>	<input type="checkbox"/>	<input type="checkbox"/>	<input type="checkbox"/>	<input type="checkbox"/>

Cycle	Options	
	Pre Soak	Delay End
NORMAL	<input type="checkbox"/>	<input type="checkbox"/>
HEAVY DUTY	<input type="checkbox"/>	<input type="checkbox"/>
WHITES	<input type="checkbox"/>	<input type="checkbox"/>
BEDDING	<input type="checkbox"/>	<input type="checkbox"/>
ACTIVEWEAR	<input type="checkbox"/>	<input type="checkbox"/>
QUICK WASH	<input type="checkbox"/>	<input type="checkbox"/>
DELICATES	<input type="checkbox"/>	<input type="checkbox"/>
PERM PRESS	<input type="checkbox"/>	<input type="checkbox"/>
RINSE+SPIN	<input type="checkbox"/>	<input type="checkbox"/>
SELF CLEAN ⁺	<input type="checkbox"/>	<input type="checkbox"/>

Operations

Operations

Special features

Delay End

You can set the washer to finish your wash automatically at a later time by choosing a delay of between 1 to 24 hours (in 1 hour increments). The hour displayed indicates the time the wash will finish.

1. Select a cycle. Then, change the cycle settings if necessary.
2. Press **Delay End** repeatedly until a desired end time is set.
3. Press and hold **Start/Pause (Hold to Start)**.
4. To cancel Delay End, restart the washer by pressing **Power**.

Real-life case

You want to finish a two-hour cycle 3 hours from now. To do this, you add the Delay End option to the current cycle with a 3-hour setting, and then press and hold **Start/Pause (Hold to Start)** at 2:00 pm. The washer starts operating at 3:00 pm and ends at 5:00 pm. Provided below is the time line for this example.

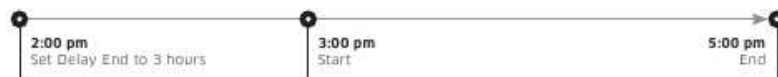

ATC (Auto Temperature Control)

ATC enables the washer to control water temperatures in each washing cycle using the internal thermistor. It is designed to maintain certain washing temperatures for best results.

NOTE

- If you select **NORMAL** or **HEAVY DUTY**, you may notice the washer supplying cold water. This is normal because the machine is designed to reduce power consumption. In these cycles, the water temperature for Level 5 is similar to bath-water temperatures, and Level 3 is similar to comfortable swimming pool temperatures.
- To wash clothes at a specific temperature, you must choose a different cycle first.

Child Lock

The Child Lock function locks the washer door to prevent children from climbing into and suffocating inside the drum.

- To activate or deactivate Child Lock, press and hold both **Temp.** and **Rinse** for 3 seconds.
 - When Child Lock is activated, the door locks and the Child Lock indicator turns on. All the buttons on the control panel becomes inactive, and you must deactivate Child Lock to use the control panel.
 - When Child Lock is deactivated, the door unlocks and the Child Lock indicator turns off. All the buttons on the control panel becomes active, and you can use the control panel.

NOTE

To add laundry after activating Child Lock, deactivate Child Lock or restart the washer.

Alarm Off

You can turn the alarm sound on or off. When the alarm is off, the cycle completion melody and the power-off beep will not sound. However, the other sounds stay active.

- Press **Alarm Off** to turn the alarm on or off.
- Your setting will be kept even after you turn off and then restart the appliance.

Maintenance

Keep the washer clean for best performance and to lengthen its life cycle.

WARNING

Certain internal parts are intentionally not grounded and may present a risk of electric shock only during servicing. Service personnel - Do not contact the following parts while the appliance is energized: Control board, heat sink, motor, inlet valve and pump.

Self Clean⁺

Certain usage and environmental conditions may result in some residue build-up or odor in the washer drum. To prevent this build-up of residue or odor causing bacteria and keep your washer drum fresh and clean, perform the SELF CLEAN⁺ cycle at least once a month or every 40 cycles. Perform the recommended procedure below when using the SELF CLEAN⁺ cycle.

1. Remove all items from the washer drum and ensure the drum is empty. Laundry left in the drum during the SELF CLEAN⁺ cycle may be damaged.
2. Press **Power** to turn on the washer.
3. Turn the **Cycle Selector** to **SELF CLEAN⁺**.
4. Press and hold **Start/Pause (Hold to Start)**.

NOTE

- The water temperature for SELF CLEAN⁺ is defaulted to Hot. This temperature cannot be changed.
- In the case where residue is present in the washer drum, add liquid chlorine bleach to the MAX level line in the main-wash compartment before starting the SELF CLEAN⁺ cycle. Do not add the liquid chlorine bleach to the bleach compartment (This is only the case for SELF CLEAN⁺ cycle).
- Do not exceed the max line. Do not use or mix any other detergent or chemicals during the SELF CLEAN⁺ cycle. If necessary, run a RINSE+SPIN cycle after the SELF CLEAN⁺ cycle has completed to help remove any remaining residue.

CAUTION

If there is chlorine bleach left in the washer drum for an extended period of time, rust can occur.

SELF CLEAN⁺ reminder

- After 40 washing cycles, the SELF CLEAN⁺ LED reminder icon and the SELF CLEAN⁺ cycle LED will blink on the control panel for an hour and then turn off automatically.
- The reminder will appear on the control panel for 5 additional consecutive cycles before turning off. The next reminder will not appear until another 40 cycles have been completed.

Smart Care

To enable this function, you must first download the Samsung Laundry app from the Play Store or the App Store and install it on a mobile device that has a camera function. The Smart Care function has been optimized for Galaxy and iPhone mobile devices (applicable models only).

1. When the washer detects an issue to check, an information code appears on the display. To enter Smart Care mode, press **Smart Care**.
2. The washer starts the self-diagnosis procedure and displays an information code if a problem is detected.
3. Run the Samsung Laundry app on your mobile device, and then tap **Smart Care**.
4. Put the mobile device close to the washer's display so that the smartphone camera and the washer face each other. The information code will be recognized automatically by the app.
5. When the information code is recognized correctly, the app provides detailed information about the problem with applicable solutions.

NOTE

- The function name, Smart Care, may differ depending on the language.
- If the washer's display reflects light, the app may fail to recognize the information code.
- If the app fails to recognize the information code, you can enter the code manually on the app.

Maintenance

Emergency drain

In case of a power failure, drain the water inside the drum before taking out the laundry.

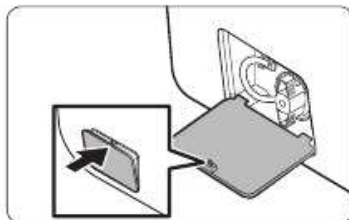

1. Turn off the washer, and then unplug the power cord.
2. Gently press the top area of the **filter cover** to open.

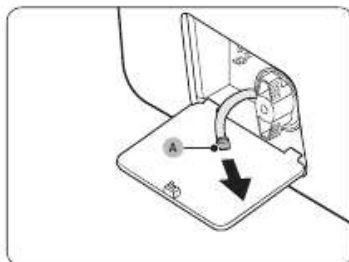

3. Put an empty, spacious container around the cover, and stretch the **emergency drain tube** to the container while holding the **tube cap (A)**.

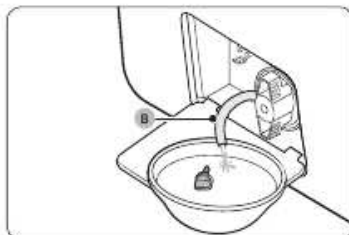

4. Open the **tube cap** and let water in the **Emergency drain tube (B)** flow into the container.
5. When done, close the **tube cap**, and reinsert the tube. Then, close the **filter cover**.

NOTE

Use a spacious container because the water in the drum may be more than expected.

Cleaning

Surface of the washer

Use a soft cloth with a nonabrasive household cleaner. Do not spray water onto the washer.

Mesh filter

Clean the mesh filter of the water hose once or twice a year.

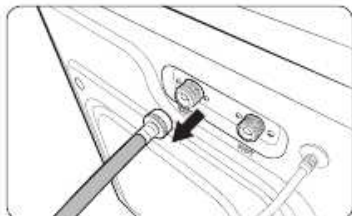

1. Turn off the washer, and then unplug the power cord.
2. Close the water tap.
3. Loosen and disconnect the water hoses from the back of the washer. Cover the each hose with a cloth to prevent water from gushing out.

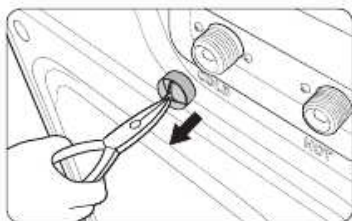

4. Use pliers to pull out the mesh filter from the inlet valves.
5. Thoroughly clean the mesh filters in water.
6. Completely dry the mesh filters. Do not dry in direct sunlight.
7. Reinsert the mesh filters, and then reconnect the water hoses.
8. Open the water taps.

NOTE

If a mesh filter is clogged, the "4C" information code appears on the washer's display screen.

Maintenance

Pump filter

You should clean the pump filter 5 or 6 times a year to prevent it from clogging. A clogged pump filter may reduce the bubble effect.

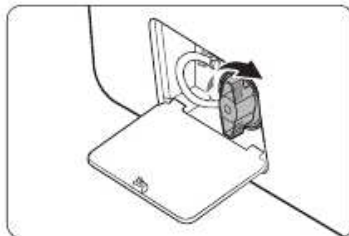
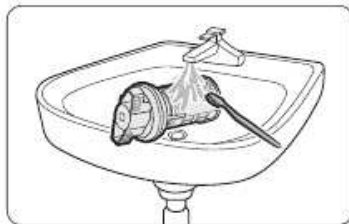
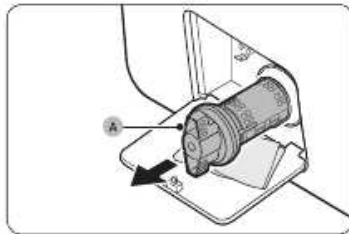

1. Turn off the washer, and then unplug the power cord.
2. Gently press the top area of the **filter cover** to open.
3. Drain the remaining water inside the drum. See the **Emergency drain** section on page 42.
4. Turn the **pump filter knob (A)** counterclockwise, and then drain the remaining water.
5. Clean the **pump filter** using a soft brush. Make sure the drain pump propeller inside the filter is not clogged.
6. Reinsert the **pump filter**, and then turn the filter knob clockwise.
7. Close the **filter cover**.

NOTE

- Some pump filters feature a safety knob that is designed to prevent children from accidentally opening the filter compartment. To open the safety knob of the **pump filter**, push in and turn it counterclockwise. The spring mechanism of the safety knob helps open the filter.
- To close the safety knob of the **pump filter**, turn it clockwise. The spring makes a rattling sound, which is normal.
- Before closing the **filter cover**, make sure the **pump filter** is properly inserted.

NOTE

If the pump filter is clogged, the "5C" information code appears on the washer's display screen.

CAUTION

- Make sure the filter knob is closed properly after cleaning the filter. Otherwise, this may cause a leak.
- Make sure the filter is inserted properly after cleaning it. Otherwise, this may cause an operational failure or a leak.

Detergent drawer

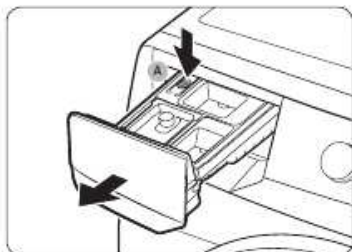

1. Open the drawer.
2. While holding down the **release lever (A)**, remove the drawer.
3. Remove the **liquid detergent container** from the drawer.



4. Clean the drawer components in running water using a soft brush.

NOTE

Other parts of the drawer can also be removed. They can fall out if you hold the drawer upside down.

Maintenance

Maintenance

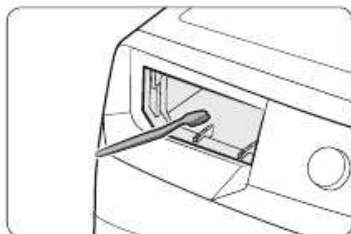

5. Clean the drawer recess using a soft brush.
6. Reinsert the **liquid detergent container** into the detergent drawer.
7. Slide the drawer into the drawer recess, and then push it inward until it is fully closed.

NOTE

To remove remaining detergent, run the **RINSE+SPIN** cycle with the drum empty.

Door diaphragm

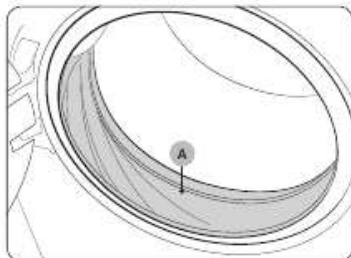

1. Open the door, and then empty the drum.
2. Combine 3/4 cups of liquid chlorine bleach and 1 gallon of warm tap water.
3. Wearing rubber gloves, use a soft, clean cloth dipped in the water and bleach solution to clean the diaphragm.
4. Let stand 5 minutes, and then wipe up and dry well.

CAUTION

Use bleach carefully and be sure to follow the bleach manufacturer's use and care instructions.

Recovery from freezing

The washer may freeze when the temperature in its location drops below 32 °F (0 °C).

1. Turn off the washer, and then unplug the power cord.
2. Pour warm water over the water tap to loosen the water hose.
3. Disconnect the water hose, and then soak it in warm water.
4. Pour warm water into the drum and leave it for about 10 minutes.
5. Reconnect the water hose to the water tap.

 **NOTE**

If the washer still doesn't operate normally, repeat the steps above.

Care for an extended period of non-use

Avoid leaving the washer unused for an extended time. However, if you intend to leave the washer unused for a long period of time, follow the directions below:

1. Press **Power**, and then turn the **Cycle Selector** to **RINSE+SPIN**.
2. Empty the drum, and then press and hold **Start/Pause (Hold to Start)**.
3. When the cycle is complete, close the water taps and disconnect the water hoses.
4. Turn off the washer, and then unplug the power cord.
5. Open the door to let air circulate through the drum.

Cleaning the exterior

1. Turn off the water taps after finishing the day's washing.
This will shut off the water supply to your washer and prevent the unlikely possibility of damage from escaping water. Leave the door open to allow the inside of your washer to dry out.
2. Use a soft cloth to wipe up all detergent, bleach, or other spills as they occur. Clean the following as recommended below:
 - Control Panel - Clean with a soft, damp cloth. Do not use abrasive powders or cleaning pads. Do not spray cleaners directly on the panel.
 - Cabinet - Clean with soap and water.

Cleaning the interior

Clean the interior of your washer periodically to remove any dirt, soil, odor, mold, mildew, or bacterial residue that may remain in your washer as a result of washing clothes.

 **CAUTION**

Failure to follow these instructions may result in unpleasant conditions, including odors and/or permanent stains on your washer or laundry.

 **NOTE**

Hard water deposits may be removed, if needed. Use a cleaner labeled "Washer safe".

Troubleshooting

Checkpoints

If you encounter a problem with the washer, first check the table below and try the suggestions.

Problem	Action
Does not start.	<ul style="list-style-type: none">• Make sure the washer is plugged in.• Make sure the door is properly closed.• Make sure the faucets are open.• Make sure to press or tap Start/Pause (Hold to Start) to start the washer.• Make sure Child Lock is not activated.• Before the washer starts to fill, it will make a series of clicking noises to check the door lock and does a quick drain.• Check the fuse or reset the circuit breaker.
Water supply is insufficient, or no water is supplied.	<ul style="list-style-type: none">• Fully open the faucet.• Make sure the door is properly closed.• Make sure the water supply hose is not frozen.• Make sure the water supply hose is not kinked or clogged.• Make sure there is sufficient water pressure.
After a cycle, detergent remains in the detergent drawer.	<ul style="list-style-type: none">• Make sure the washer is running with sufficient water pressure.• Make sure you add liquid detergent to the liquid detergent container. Make sure to remove the liquid detergent container if you are using powdered detergent.• Clean the detergent drawer.
Excessive vibrations or makes noise.	<ul style="list-style-type: none">• Make sure the washer is installed on a level, solid floor that is not slippery. If the floor is not level, use the leveling feet to adjust the height of the washer.• Make sure the shipping bolts are removed.• Make sure the washer is not contacting any other object.• Make sure the laundry load is balanced.• The motor can cause noise during normal operation.• Overalls or metal-decorated clothes can cause noise while being washed. This is normal.• Metal objects such as coins can cause noise. After washing, remove these objects from the drum or filter case.• Remove the filling of the pillows and cushions, and wash only the covers.

Problem	Action
Does not drain and/or spin.	<ul style="list-style-type: none"> • Make sure the drain hose is neither kinked nor obstructed all the way to the drain system. If there is a drain restriction, call for service. • Make sure the debris filter is not clogged. • Close the door and press or tap Start/Pause (Hold to Start). For your safety, the washer will not tumble or spin unless the door is closed. • Make sure the drain hose is not frozen or clogged. • Make sure the drain hose is connected to a drain system that is not clogged. • If the washer is not supplied with sufficient power, the washer temporarily will not drain or spin. As soon as the washer regains sufficient power, it will operate normally.
The door does not open.	<ul style="list-style-type: none"> • Press or tap Start/Pause (Hold to Start) to stop the washer. • It may take a few moments for the door lock mechanism to disengage. • Make sure all the water in the drum is drained. • The door may not open if water remains in the drum. Drain the drum and open the door manually. • Make sure the door lock light is off. The door lock light turns off after the washer has drained. • If the washer is paused after the water is supplied, the door cannot be opened until one minute has passed. If draining occurs followed by the information code on the display, the door will not open until 3 minutes after the washer has stopped or the power is turned off.
Excessive suds.	<ul style="list-style-type: none"> • Make sure you use the recommended types and amounts of detergent. • Use high efficiency (HE) detergent to prevent oversudsing. • Reduce the detergent amount for soft water, small loads, or lightly soiled loads. • Don't use Non-HE detergent.
Cannot add additional detergent.	<ul style="list-style-type: none"> • Make sure the remaining amount of detergent and fabric softener is not over the limit.

Troubleshooting

Troubleshooting

Troubleshooting

Problem	Action
The washer stops.	<ul style="list-style-type: none"> • Plug the power cord into a live electrical outlet. • Check the fuse or reset the circuit breaker. • Close the door and press Start/Pause (Hold to Start) to start the washer. For your safety, the washer will not tumble or spin unless the door is closed. • Before the washer starts to fill, it will make a series of clicking noises to check the door lock and does a quick drain. • There may be a pause or soak period in the cycle. Wait briefly and the washer may start. • Make sure the mesh filter of the water supply hose at the faucets is not clogged. Periodically clean the mesh filter. • If the washer is not supplied with sufficient power, the washer temporarily will not drain or spin. As soon as the washer regains sufficient power, it will operate normally.
Fills with the wrong temperature water.	<ul style="list-style-type: none"> • Fully open both taps. • Make sure the temperature selection is correct. • Make sure the hoses are connected to the correct taps. Flush water lines. • Make sure your water heater is set to supply hot water with a minimum temperature of 120 °F (49 °C) at the tap. Also, check the water heater capacity and recovery rate. • Disconnect the hoses and clean the mesh filters. The mesh filters may be clogged. • While the washer fills, the water temperature may change as the automatic temperature control feature checks incoming water temperature. This is normal. • While the washer fills, you may notice just hot and/or just cold water going through the dispenser when cold or warm temperatures are selected. This is a normal function of the automatic temperature control feature as the washer determines the water temperature.
The load is wet at the end of a cycle.	<ul style="list-style-type: none"> • Use the High or Extra High spin speed. • Use high efficiency (HE) detergent to reduce oversudsing. • The load is too small. Small loads (one or two items) may become unbalanced and not spin completely. • Make sure the drain hose is not kinked or clogged.

Problem	Action
Leaks water.	<ul style="list-style-type: none"> • Make sure the door is properly closed. • Make sure all hose connections are tight. • Make sure the end of the drain hose is correctly inserted and secured to the drain system. • Avoid overloading. • Use high efficiency (HE) detergent to prevent oversudsing.
Has odors.	<ul style="list-style-type: none"> • Excessive suds collect in recesses and can cause foul odors. • Run cleansing cycles to sanitize periodically. • Clean the door seal (diaphragm). • Dry the washer interior after a cycle has finished.
After a cycle, washer is not off and/or the door does not open.	<ul style="list-style-type: none"> • If the Remaining Laundry Notification is on, press Power to turn the power off, and then remove the items. • If the SELF CLEAN⁺ indicator is on, remove all items from the drum, and then run the SELF CLEAN⁺ cycle.

If a problem persists, contact a local Samsung service center.

Troubleshooting

Information codes

If the washer fails to operate, you may see an information code on the screen. Check the table below and try the suggestions.

Code	Action
1C	Check the water level sensor. <ul style="list-style-type: none">Power the washer off. Wait 2-3 minutes, power the washer on, and then try again.Depending on the model, the drain system drains water automatically. The Power and Start/Pause (Hold to Start) buttons may be disabled during this process.
DC	The door is open. <ul style="list-style-type: none">Close the door and press Start/Pause (Hold to Start) to resume operation.
DC1	Check the door switch. <ul style="list-style-type: none">Power the washer off. Wait 2-3 minutes, power the washer on, and then try again.
LC	Check for water leaks. <ul style="list-style-type: none">Power the washer off, and then check the drain system for any leaks. Once the leak issue is resolved, power the washer on.Depending on the model, the drain system may drain water automatically. The Power and Start/Pause (Hold to Start) buttons may be disabled during this process.
4C	Check the water supply line. <ul style="list-style-type: none">Check the connection to the water lines (including water taps).Power the washer off. Wait 2-3 minutes, power the washer on, and then try again.Depending on the model, the drain system may drain water automatically. The Power and Start/Pause (Hold to Start) buttons may be disabled during this process.
4C2	Laundry needs protection because the water being supplied is too hot. <ul style="list-style-type: none">Make sure the cold and hot water taps are properly connected.Power the washer off. Wait 2-3 minutes, power the washer on, and then try again.
5C	Check the drain system. <ul style="list-style-type: none">Make sure the drain filter is not clogged.If the drain filter is clogged, clean the filter, and then restart the washer.

Code	Action
HC	<p>Check the washing heater.</p> <ul style="list-style-type: none"> Power off the washer, and then contact a Samsung service center.
UB	<p>Check the spinning process.</p> <ul style="list-style-type: none"> The load may not be balanced inside the drum. Check the drum and make sure the load is balanced. Press Start/Pause (Hold to Start) to resume operation or power the washer off, wait 2-3 minutes, power the washer on, and then try again.
8C, 8C1, 8C2	<p>Check the MEMS sensor.</p> <ul style="list-style-type: none"> Power the washer off. Wait 2-3 minutes, power the washer on, and then try again.
OC	<p>Water may overflow.</p> <ul style="list-style-type: none"> Close the water valve and call for service.
3C	<p>Check the motor.</p> <ul style="list-style-type: none"> Power the washer off. Wait 2-3 minutes, power the washer on, and then try again.
AC6	<p>Check the PBA communication status.</p> <ul style="list-style-type: none"> Power the washer off. Wait 2-3 minutes, power the washer on, and then try again.
9C1, 9C2	<p>The electronic control needs to be checked.</p> <ul style="list-style-type: none"> Check if power is supplied properly. If the information code remains, contact a Samsung service center.
SF	<p>System failed.</p> <ul style="list-style-type: none"> Power off the washer, and then contact a Samsung service center.





If any information code keeps appearing on the screen, contact a local Samsung service center.

Specifications

Fabric care chart

The following symbols provide garment care direction. The clothing care labels include symbols for drying, bleaching, drying and ironing, or dry cleaning when necessary. The use of symbols ensures consistency among garment manufacturers of domestic and imported items. Follow care label directions to optimize garment life and reduce laundering problems.

Wash cycle

	Normal
	Permanent press/Wrinkle resistant/Wrinkle control
	Gentle/Delicates
	Hand wash



Water temperature

...	Hot
..	Warm
.	Cold

NOTE

The temperature range for Hot is 135 °F (57 °C) or below, 95 °F (35 °C) or below for Warm, and 68 °F (20 °C) or below for Cold. Wash water temperature must be a minimum of 60 °F (16 °C) for detergent activation and effective cleaning.

Bleach

	Any bleach (when needed)
	Only non-chlorine (color-safe) bleach (when needed)
	Tumble dry

Normal

	Permanent press/Wrinkle resistant/Wrinkle control
	Gentle/Delicates

Special instructions

	Line dry/Hang to dry
	Drip dry
	Dry flat







Heat setting

	High
	Medium
	Low
	Any heat
	No heat / Air





Iron dry or steam temperatures

	High
	Medium
	Low

Warning symbols for laundering

	Do not wash
	Do not wring
	Do not bleach
	Do not tumble dry
	No steam (added to iron)
	Do not iron

Dry-clean

	Dry-clean
	Do not dry-clean
	Line dry / Hang to dry
	Drip dry
	Dry flat

Protecting the environment

- This appliance is manufactured from recyclable materials. If you decide to dispose of it, please observe local waste disposal regulations. Cut off the power cord so that the appliance cannot be connected to a power source. Remove the lid so that animals and small children cannot get trapped inside the appliance.
- Do not exceed the detergent quantities recommended in the detergent manufacturers' instructions.
- Use stain removal products and bleaches before the wash cycle only when necessary.
- Save water and electricity by only washing full loads (the exact amount depends upon the program used).

Declaration of conformity

This appliance complies with UL2157.

Specifications

Specifications

Specification sheet

Type		Front loading washer	
		WF45T6000A*	
Capacity (Cu.ft)		4.5	
Water pressure (psi (kPa))		20-116 (137-800)	
NET weight (lb (kg))		201 (91.0)	
Spin revolution (rpm)		1200	
Heating Rating (W)		900	
Power consumption (W)	Washing	120 V	200
	Washing and Heating		1150
	Spin		550
	Drain		80

LIMITED WARRANTY (U.S.A.)

SAMSUNG WASHER

LIMITED WARRANTY TO ORIGINAL CONSUMER PURCHASER WITH PROOF OF PURCHASE

This SAMSUNG brand product, as supplied and distributed by SAMSUNG ELECTRONICS AMERICA, INC. (SAMSUNG) and delivered new, in the original carton to the original consumer purchaser, is warranted by SAMSUNG against manufacturing defects in materials or workmanship for the limited warranty period, starting from the date of original purchase, of:

One (1) year parts and labor,

Three (3) years stainless tub part (Part Only),

Ten (10) years washing DD motor part (Part Only)

This limited warranty is valid only on products purchased and used in the United States that have been installed, operated, and maintained according to the instructions attached to or furnished with the product. To receive warranty service, the purchaser must contact SAMSUNG at the address or phone number provided below for problem determination and service procedures. Warranty service can only be performed by a SAMSUNG authorized service center. The original dated bill of sale must be presented upon request as proof of purchase to SAMSUNG or SAMSUNG's authorized service center to receive warranty service.

SAMSUNG will provide in-home service within the contiguous United States during the warranty period at no charge, subject to availability of SAMSUNG authorized servicers within the customer's geographic area. If in-home service is not available, SAMSUNG may elect, at its option, to provide transportation of the product to and from an authorized service center. If the product is located in an area where service by a SAMSUNG authorized servicer is not available, you may be responsible for a trip charge or required to bring the product to a SAMSUNG authorized service center for service.

To receive in-home service, product must be unobstructed and accessible to the service agent.

During the applicable warranty period, a product will be repaired, replaced, or the purchase price refunded, at the sole option of SAMSUNG. SAMSUNG may use new or reconditioned parts in repairing a product, or replace the product with a new or reconditioned product. Replacement parts and products are warranted for the remaining portion of the original product's warranty or ninety (90) days, whichever is longer. All replaced parts and products are the property of SAMSUNG and you must return them to SAMSUNG.

LIMITED WARRANTY (U.S.A.)

This limited warranty covers manufacturing defects in materials or workmanship encountered in normal household, noncommercial use of this product and shall not cover the following: damage that occurs in shipment, delivery, installation, and uses for which this product was not intended; damage caused by unauthorized modification or alteration of the product; product where the original factory serial numbers have been removed, defaced, changed in any way, or cannot be readily determined; cosmetic damage including scratches, dents, chips, and other damage to the product's finishes; damage caused by abuse, misuse, pest infestations, accident, fire, floods, or other acts of nature or God; damage caused by use of equipment, utilities, services, parts, supplies, accessories, applications, installations, repairs, external wiring or connectors not supplied or authorized by SAMSUNG; damage caused by incorrect electrical line current, voltage, fluctuations and surges; damage caused by failure to operate and maintain the product according to instructions; in-home instruction on how to use your product; and service to correct installation not in accordance with electrical or plumbing codes or correction of household electrical or plumbing (i.e., house wiring, fuses, or water inlet hoses). The cost of repair or replacement under these excluded circumstances shall be the customer's responsibility.

Visits by an authorized servicer to explain product functions, maintenance or installation are not covered by this limited warranty. Please contact SAMSUNG at the number below for assistance with any of these issues.

EXCLUSION OF IMPLIED WARRANTIES

IMPLIED WARRANTIES, INCLUDING THE IMPLIED WARRANTIES OF MERCHANTABILITY OR FITNESS FOR A PARTICULAR PURPOSE, ARE LIMITED TO ONE YEAR OR THE SHORTEST PERIOD ALLOWED BY LAW. Some states do not allow limitations on how long an implied warranty lasts, so the above limitations or exclusions may not apply to you. This warranty gives you specific rights, and you may also have other rights, which vary from state to state.

LIMITATION OF REMEDIES

YOUR SOLE AND EXCLUSIVE REMEDY IS PRODUCT REPAIR, PRODUCT REPLACEMENT, OR REFUND OF THE PURCHASE PRICE AT SAMSUNG'S OPTION, AS PROVIDED IN THIS LIMITED WARRANTY. SAMSUNG SHALL NOT BE LIABLE FOR SPECIAL, INCIDENTAL OR CONSEQUENTIAL DAMAGES, INCLUDING BUT NOT LIMITED TO TIME AWAY FROM WORK, HOTELS AND/OR RESTAURANT MEALS, REMODELING EXPENSES, LOSS OF REVENUE OR PROFITS, FAILURE TO REALIZE SAVINGS OR OTHER BENEFITS REGARDLESS OF THE LEGAL THEORY ON WHICH THE CLAIM IS BASED, AND EVEN IF SAMSUNG HAS BEEN ADVISED OF THE POSSIBILITY OF SUCH DAMAGES. Some states do not allow exclusion or limitation of incidental or consequential damages, so the above limitations or exclusions may not apply to you. This warranty gives you specific rights, and you may also have other rights, which vary from state to state.

SAMSUNG does not warrant uninterrupted or error-free operation of the product. No warranty or guarantee given by any other person, firm, or corporation with respect to this product shall be binding on SAMSUNG.

To obtain warranty service, please contact SAMSUNG at:

Samsung Electronics America, Inc.
85 Challenger Road
Ridgefield Park, NJ 07660
1-800-SAMSUNG (726-7864)
www.samsung.com/us/support

Warranty (CANADA)

SAMSUNG WASHER

LIMITED WARRANTY TO ORIGINAL PURCHASER

This SAMSUNG brand product, as supplied and distributed by SAMSUNG ELECTRONICS CANADA, INC. (SAMSUNG) and delivered new, in the original carton to the original consumer purchaser, is warranted by SAMSUNG against manufacturing defects in materials and workmanship for a limited warranty period of:

One (1) year part and labor, Ten (10) years washing DD motor (Part only)

This limited warranty begins on the original date of purchase, and is valid only on products purchased and used in the Canada. To receive warranty service, the purchaser must contact SAMSUNG for problem determination and service procedures. Warranty service can only be performed by a SAMSUNG authorized service center. The original dated bill of sale must be presented upon request as proof of purchase to SAMSUNG or SAMSUNG's authorized service center. SAMSUNG will provide in-home service during the warranty period at no charge, subject to availability within the Canada. In-home service is not available in all areas.

To receive in-home service, product must be unobstructed and accessible to the service agent. If service is not available, SAMSUNG may elect to provide transportation of the product to and from an authorized service center.

SAMSUNG will repair, replace, or refund this product at our option and at no charge as stipulated herein, with new or reconditioned parts or products if found to be defective during the limited warranty period specified above. All replaced parts and products become the property of SAMSUNG and must be returned to SAMSUNG. Replacement parts and products assume the remaining original warranty, or ninety (90) days, whichever is longer. This limited warranty covers manufacturing defects in materials and workmanship encountered in normal, noncommercial use of this product and shall not apply to the following: damage that occurs in shipment; delivery and installation; applications and uses for which this product was not intended; altered product or serial numbers; cosmetic damage or exterior finish; accidents, abuse, neglect, fire, water, lightning, or other acts of nature or God; use of products, equipment, systems, utilities, services, parts, supplies, accessories, applications, installations, repairs, external wiring or connectors not supplied or authorized by SAMSUNG that damage this product or result in service problems; incorrect electrical line voltage, fluctuations and surges; customer adjustments and failure to follow operating instructions, maintenance and environmental instructions that are covered and prescribed in the instruction book; product removal and reinstallation; problems caused by pest infestations. This limited warranty does not cover problems resulting from incorrect electric current, voltage or supply, light bulbs, house fuses, house wiring, cost of a service call for instructions, or fixing installation errors. SAMSUNG does not warranty uninterrupted or error-free operation of the product.

EXCEPT AS SET FORTH HEREIN, THERE ARE NO WARRANTIES ON THIS PRODUCT EITHER EXPRESS OR IMPLIED, AND SAMSUNG DISCLAIMS ALL WARRANTIES INCLUDING, BUT NOT LIMITED TO, ANY IMPLIED WARRANTIES OF MERCHANTABILITY, INFRINGEMENT OR FITNESS FOR A PARTICULAR PURPOSE.

NO WARRANTY OR GUARANTEE GIVEN BY ANY PERSON, FIRM, OR CORPORATION WITH RESPECT TO THIS PRODUCT SHALL BE BINDING ON SAMSUNG. SAMSUNG SHALL NOT BE LIABLE FOR LOSS OF REVENUE OR PROFITS, FAILURE TO REALIZE SAVINGS OR OTHER BENEFITS, OR ANY OTHER SPECIAL, INCIDENTAL OR CONSEQUENTIAL DAMAGES CAUSED BY THE USE, MISUSE, OR INABILITY TO USE THIS PRODUCT, REGARDLESS OF THE LEGAL THEORY ON WHICH THE CLAIM IS BASED, AND EVEN IF SAMSUNG HAS BEEN ADVISED OF THE POSSIBILITY OF SUCH DAMAGES.

NOR SHALL RECOVERY OF ANY KIND AGAINST SAMSUNG BE GREATER IN AMOUNT THAN THE PURCHASE PRICE OF THE PRODUCT SOLD BY SAMSUNG AND CAUSING THE ALLEGED DAMAGE. WITHOUT LIMITING THE FOREGOING, PURCHASER ASSUMES ALL RISK AND LIABILITY FOR LOSS, DAMAGE, OR INJURY TO PURCHASER AND PURCHASER'S PROPERTY AND TO OTHERS AND THEIR PROPERTY ARISING OUT OF THE USE, MISUSE, OR INABILITY TO USE THIS PRODUCT. THIS LIMITED WARRANTY SHALL NOT EXTEND TO ANYONE OTHER THAN THE ORIGINAL PURCHASER OF THIS PRODUCT, IS NONTRANSFERABLE AND STATES YOUR EXCLUSIVE REMEDY.

Warranty (CANADA)

Some provinces do not allow limitations on how long an implied warranty lasts, or the exclusion or limitation of incidental or consequential damages, so the above limitations or exclusions may not apply to you.

This warranty gives you specific rights, and you may also have other rights, which vary from province to province.

To obtain warranty service, please contact SAMSUNG at:

Samsung Electronics Canada Inc.

2050 Derry Road West,

Mississauga, Ontario L5N 0B9 Canada

1-800-SAMSUNG (726-7864)

www.samsung.com/ca/support (English)

www.samsung.com/ca_fr/support (French)

FAX : 1-866-436-4617

Visits by a Service Engineer to explain functions, maintenance, or installation are not covered by warranty.

Please contact your Samsung call agent for help with any of these issues.

— |

Memo

SAMSUNG



Scan the QR code* or visit
www.samsung.com/spsn
to view our helpful
How-to Videos and Live Shows

*Requires reader to be installed on your smartphone

Scan this with your smartphone

QUESTIONS OR COMMENTS?

COUNTRY	CALL	OR VISIT US ONLINE AT
U.S.A	1-800-SAMSUNG (726-7864)	www.samsung.com/us/support
CANADA	1-800-SAMSUNG(726-7864)	www.samsung.com/ca/support (English) www.samsung.com/ca_fr/support (French)



DC68-04006R-00